



Aerospace Solutions
Composite

D-STAD DIA-BNC (LH) DIA-HBC DIA-MFC DIA-REC HBC60 PFB D-DAD D-GDN90



INDEX



D-STAD Diamond coated straight flute triple angle drill.....	PAGE 4-7
D-DAD Diamond coated double angle drill for composites.....	PAGE 8-9
D-GDN90 Diamond coated 90° point angle drill for composites.....	PAGE 10-11
DIA-BNC (LH) Diamond coated router for multi-purpose milling.....	PAGE 12-13
DIA-HBC Diamond coated router for high feed routing and finishing in thick laminates.....	PAGE 14-15
HBC60 Bright router for AFRP, GFRP & Honeycombs.....	PAGE 18-19
DIA-REC Diamond coated roughing router.....	PAGE 20-21
DIA-MFC Diamond coated finishing router.....	PAGE 22-23
PFB Indexable finishing ball end mill.....	PAGE 24-25
PFB Inserts Applicable inserts for finish ball nose cutter.....	PAGE 26

OSG'S ULTRA-FINE DIAMOND COATED TOOLS

Patented Ultra-Fine Grain Size

OSG's patented ultra-fine diamond coating has a maximum diamond grain size diameter of 2µm. This strictly controlled diameter allows our coating to be super smooth and extremely sharp, which visually is easily distinguishable from our competition.

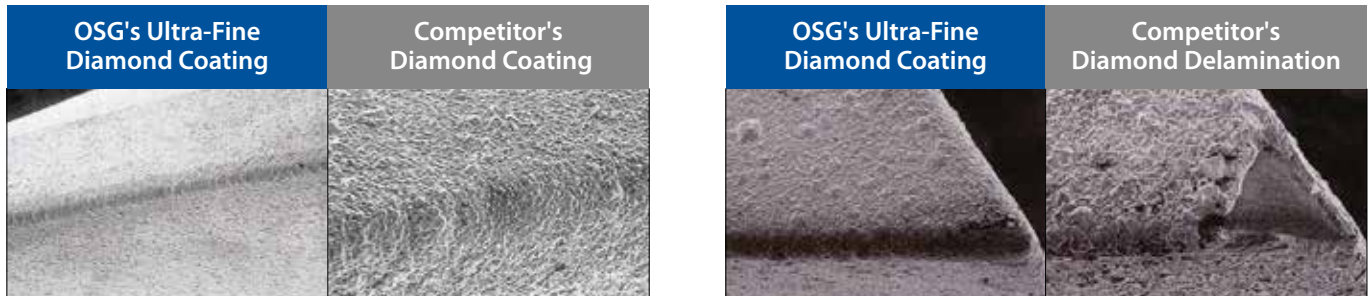

Elimination of Diamond Delamination

OSG manufactures all diamond products in-house with absolute control. We produce our carbide, design our tools and develop our coatings. The end result is a diamond coated product with consistent tool life, rather than having to endure unpredictable delamination issues like ost of our competition.



KEY FEATURES: D-STAD

Diamond Coated Straight Flute Triple Angle Drill

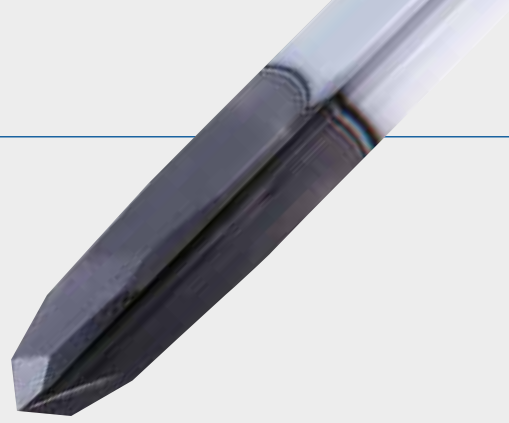

Triple Angle Geometry (PAT.)

Reduces fiber breakout and push-out delamination at hole exit.

OSG Diamond Coating (PAT.)

Provides superior wear resistance and anti-welding properties.

Straight Flute

Eliminates pull-up delamination at hole entrance.



D-STAD

Drilling | Solid carbide | 3xD

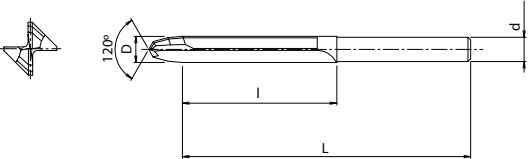

- Triple angle carbide drill with diamond coating
- Up to 3xD
- For CFRP
- 4 sizes



CARBIDE
DIA

SHRINK
FIT



0~-0.02



page 29

EDP	D	L	l	d	Price
48154001	4	80	30	4	
48154002	6	90	40	6	
48154004	6,35	88	38	6,35	
48154003	8	100	50	8	

EDP	D	L	l	d	Price

OSG's diamond coated drill vs. a competitors PCD twist drill

Patented triple angle geometry to reduce push-out exit delamination.
 Straight-fluted to eliminate pull-up entrance delamination.

Tool	D-STAD	Competitor's PCD Twist Drill
Size	6.375mm	
Work Material	CFRP	
Drilling Speed	100m/min (4,996min ⁻¹)	
Feed	300mm/min (0.06mm/rev)	
Depth of Hole	19mm (Through)	
Coolant	Water Soluble	

D-STAD vs. competitors PCD twist drill

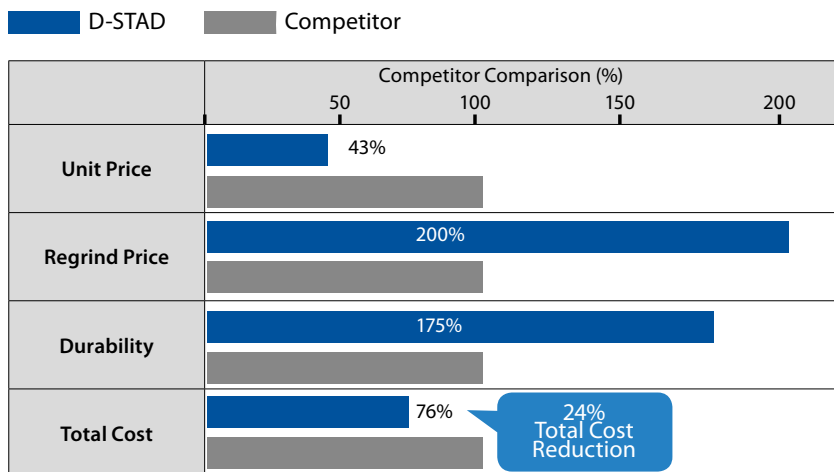

Hole quality comparison

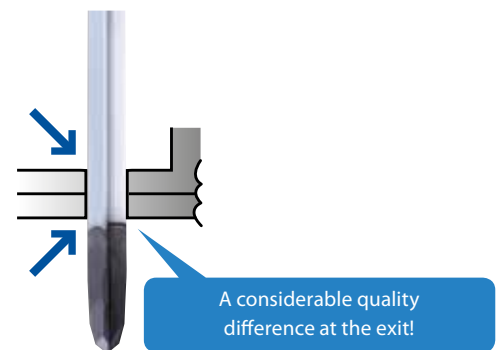
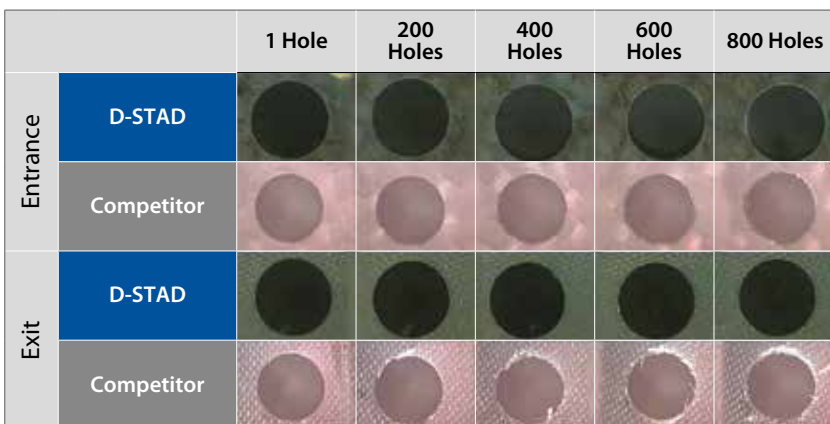

Tool life determinant: Delamination

OSG's diamond coated drill vs. a competitors diamond coated drill

D-STAD demonstrated 19 times greater tool life versus the competitor's diamond coated tool.

Tool	D-STAD	Competitor's Diamond Coated Drill
Size	6.375mm	
Work Material	CFRP	
Drilling Speed	120m/min (600min ⁻¹)	
Feed	152mm/min (0.025mm/rev)	
Depth of Cut	3mm	
Coolant	Dry	

Comparison in number of drilled holes

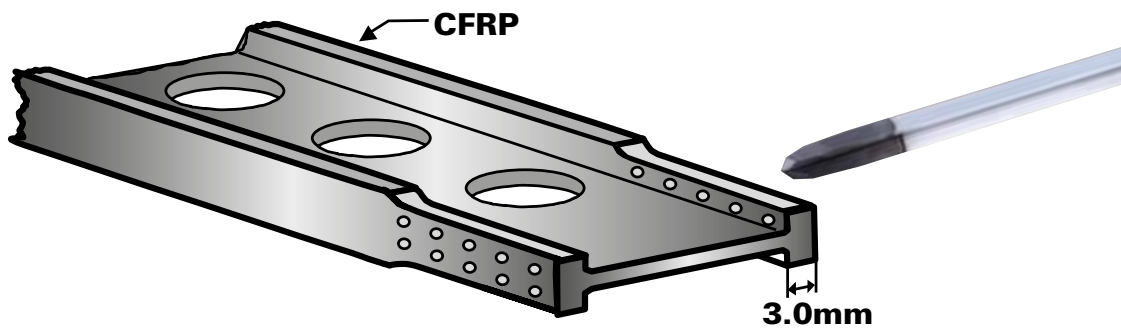
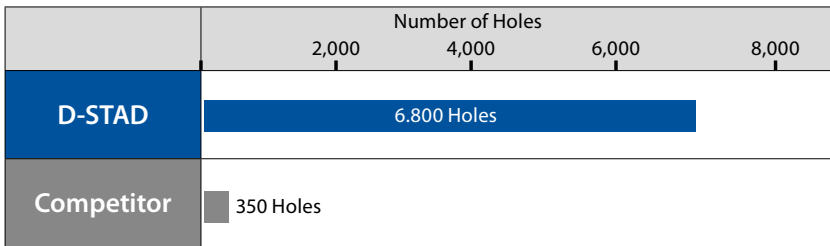

KEY FEATURES: D-DAD

Diamond Coated Double Angle Drill for Composites

Ultra fine Diamond Coating (PAT.)

- For excellent exit hole quality.
- High helix geometry.

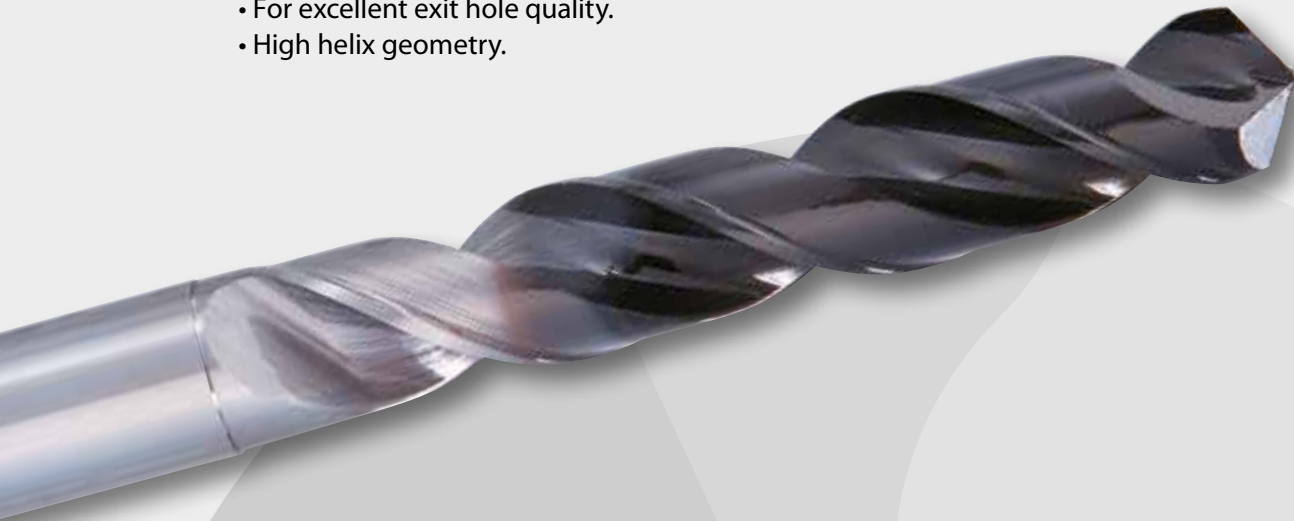

Stable tool life

D-DAD Diamond coated double angle drill for composites

Tool	D-DAD
Work Material	CFRP
Cutting Speed	60m/min (3,000min ⁻¹)
Feed Rate	228mm/min (0.076mm/rev)
Depth of Hole	5,7mm Depth Three-layer stack (through) no pecking
Coolant	Dry
Machine	Special drilling machine

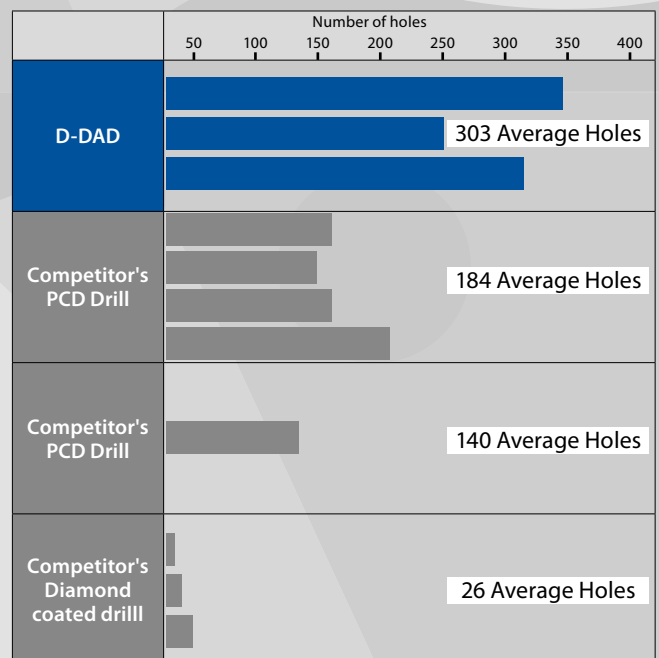

KEY FEATURES: D-GDN90

Diamond Coated 90° point angle drill for composites

Ultra fine Diamond Coating (PAT.)

- For excellent exit hole quality.
- 90 point angle geometry

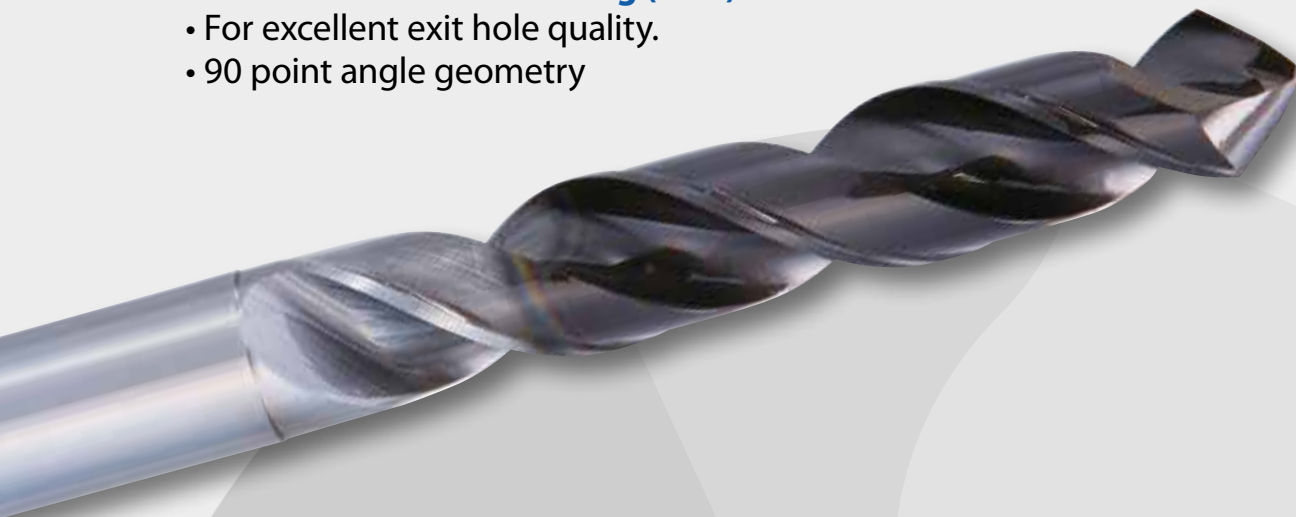

Long tool life even at high feed rate

D-GDN90 Diamond coated 90° point angle drill for composites

Tool	D-GDN90
Work Material	CFRP
Cutting Speed	100m/min (5,000min ⁻¹)
Feed Rate	228mm/min (0.076mm/rev)
Depth of Hole	10mm Through, no pecking
Coolant	Dry
Machine	Vertical machining center

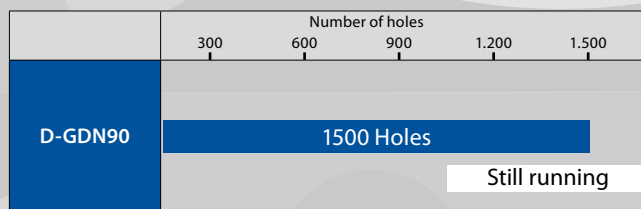

D-GDN90

Drilling | Solid carbide

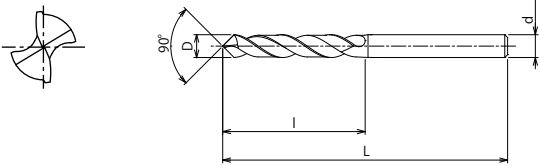

- Diamond coated 90° point angle drill
- For CFRP
- 6 sizes



CARBIDE
DIA
SHRINK FIT
0-0.02
40°
page 29

EDP	D	L	l	d	Price
8809151	2,5	50	15	2,5	
8809152	3,27	76	20	3,27	
8809153	4,1	80	25	4,1	
8809154	4,8	80	29	4,8	
8809155	6,3	94	38	6,3	
8809156	9,5	115	57	9,5	

Drilling | Solid carbide



KEY FEATURES: DIA-BNC

Diamond Coated Router for Multi-Purpose Milling

Fine Nick Geometry (PAT.)

Achieves high efficiency in both roughing and finishing applications.
Eliminates uncut fibers and delamination.

OSG Diamond Coating (PAT.)

Provides superior wear resistance and anti-welding properties.

Stringer and trimming

DIA-BNC was able to achieve four times the durability versus the competitor.

Comparison of Durability

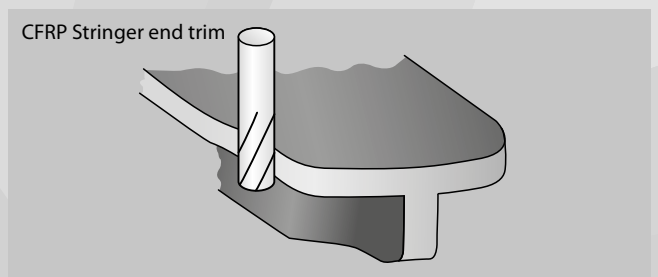
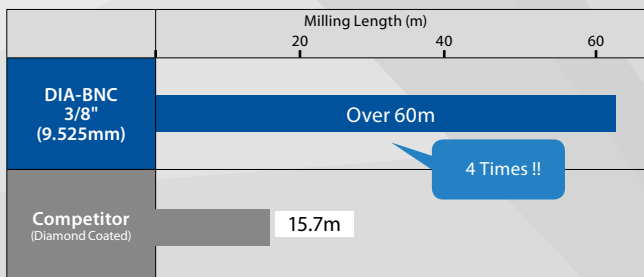

Slotting



Routing



Pocketing, Plunging & Ramping

Flute management

Longer tool life can be achieved by changing milling position of the flute.

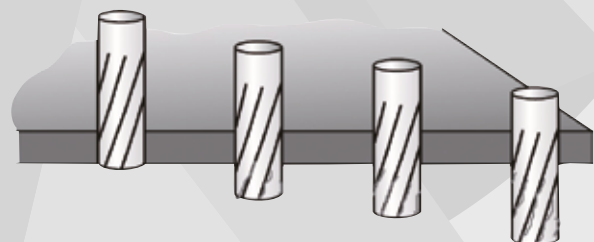

DIA-BNC

Milling | Solid carbide

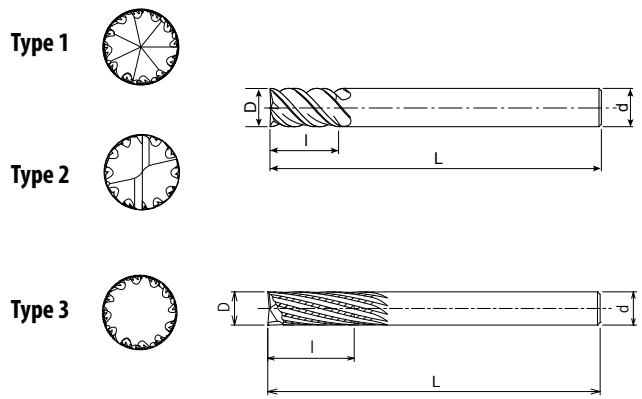

- Carbide end mills with diamond coating
- For CFRP milling
- Multi flute, fine nick geometry



CARBIDE DIA SHRINK FIT LH



EDP	Z	D	L	I	d	Type	Specification	Price
48108001	8	6	68	18	6	1	For trimming	
48108002	10	8	74	24	8	1	For trimming	
48108003	12	10	80	30	10	1	For trimming	
48108004	14	12	86	36	12	1	For trimming	
48108011	8	6	68	18	6	2	For trimming & plunging	
48108012	10	8	74	24	8	2	For trimming & plunging	
48108013	12	10	80	30	10	2	For trimming & plunging	
48108014	14	12	86	36	12	2	For trimming & plunging	
8809012	10	6	88	18	6	3	Left Helix	
8809013	14	8	94	24	8	3	Left Helix	



KEY FEATURES: DIA-HBC

Diamond Coated Router for High Feed Routing and Finishing in Thick Laminates



Compression Cutting Mechanism
Reduces delamination and uncut fibers on both top and bottom laminate surface.

Left Hand Helix (Shank Side)
Directs cutting force downward.

4-Flute Geometry
For optimal overlap and chip evacuation.

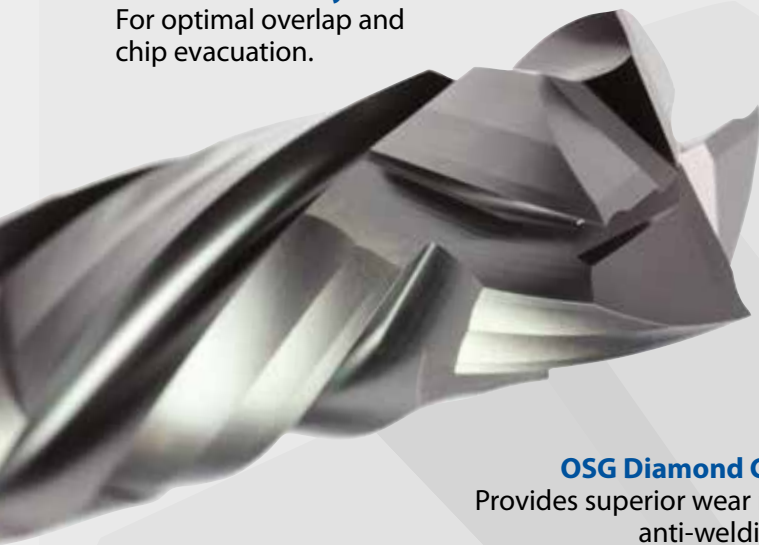

OSG Diamond Coating (PAT.)
Provides superior wear resistance and anti-welding properties.

Right Hand Helix (End Cut Side)
Directs cutting force upward.

Compression Mechanism

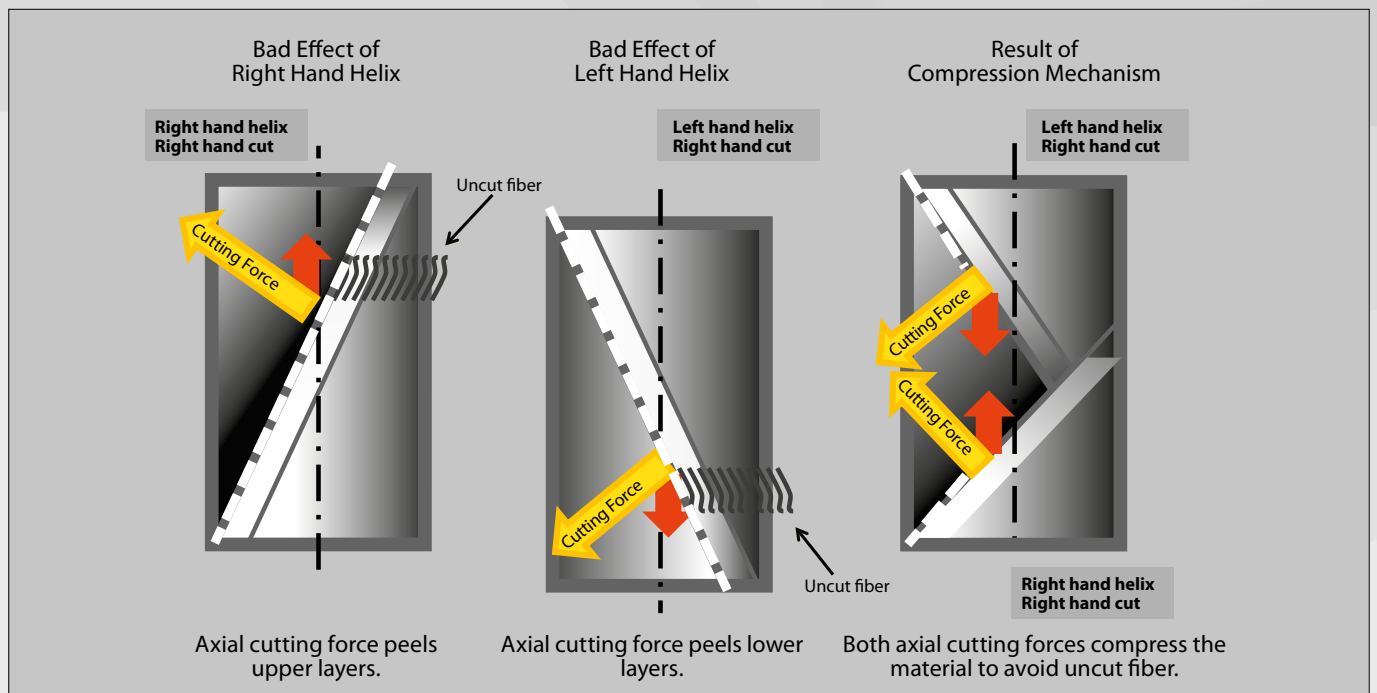

Herringbone end mill for CFRP routing

With a herringbone flute design, the DIA-HBC is capable of finishing CFRP without delamination. OSG's patented diamond coating contributes to long tool life and excellent surface finish.

Tool	DIA-HBC (Special)
Size	9.525mm
Work Material	CFRP
Milling Method	Routing
Milling Speed	96m/min (3,200min ⁻¹)
Feed	348mm/min (0.1mm/rev)
Coolant	Dry
Machine	Vertical Machining Center
Tool Life	Resin Welding

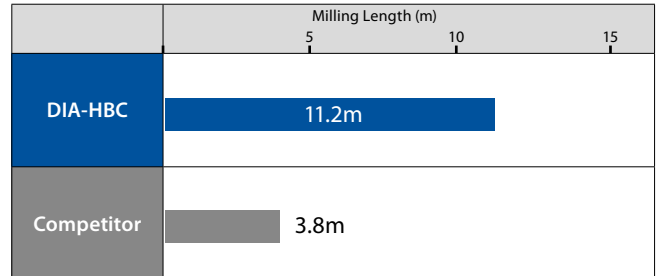

High Feed Milling

DIA-HBC4 demonstrated excellent performance and surface finish at high feed rates. This 4-flute herringbone design was able to mill up to 480 IPM without leaving streak marks on the material.

Tool	Herringbone Router - Diamond Coated	
	DIA-HBC4	Competitor
Size	.500"	
Number of Flutes	4	6
Work Material	CFRP	
Milling Method	Side Milling	
Milling Speed	6,000 RPM	
Feed	Various (24 to 480 IPM)	
Depth of Cut	$a_a = .250"$ $a_r = .125"$	
Coolant	Dry	
Machine	Vertical Machining Center	

Performance highlights

DIA-HBC4
Clean milling at
480 IPM

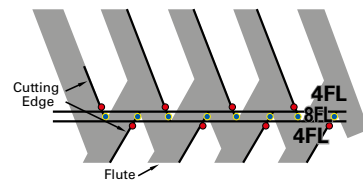

Competitor
Streaking and
Torn/Uncut Fibers

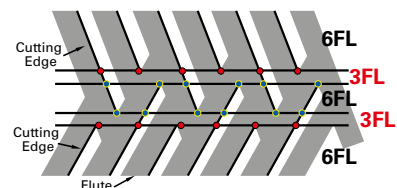



www.osgeurope.com



KEY FEATURES: HBC60

Bright Router for AFRP, GFRP & Honeycombs

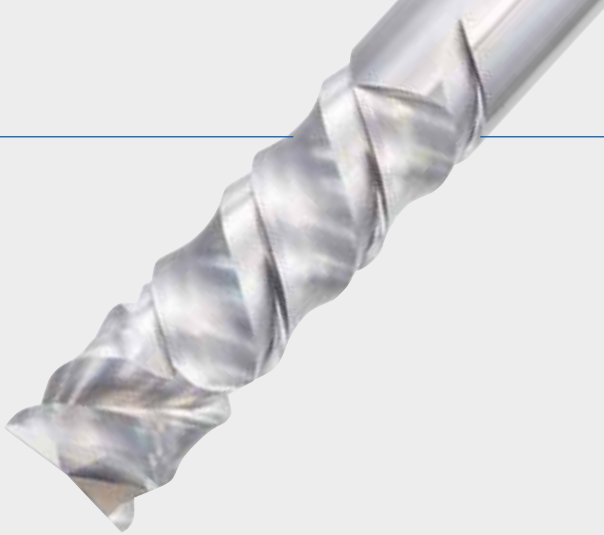



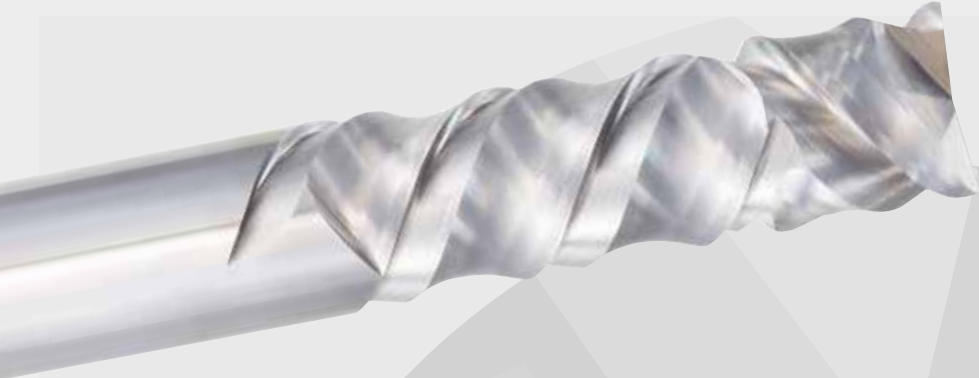



Compression Cutting Mechanism
Reduces delamination on both top and bottom laminate with its 60° helix angle.



HBC60 VS. COMPETITOR

Surface processed by the HBC60 was much smoother than conventional tool / competitor.

Work Material	
CFRP / Aluminum Honeycomb	AFRP / Nomex Honeycomb
	 Processed by Competitor
 Processed by → Conventional Tool	 Processed by HBC60
 ← Processed by HBC60	GFRP / Nomex Honeycomb
	

KEY FEATURES: DIA-REC

Diamond Coated Roughing Router

Sine Curved Nick Geometry

- Excels in roughing and semi-finishing of composites with low cutting forces.
- For low rigid fixtures, setups, weak spindles and 5-axis machines.

OSG Diamond Coating (PAT.)

Provides superior wear resistance and anti-welding properties.

Highly efficient roughing with low cutting force

Due to the roughing nick profile DIA-REC can reduce cutting force over competitor herringbone 6-flute and our DIA-BNC.

Tool	DIA-REC	DIA-BNC	Competitor Herringbone (6-Flute)
Size		.3937"	
Work Material		CFRP	
Milling Speed		656 SFM	
Feed		15.7 IPM	
Depth of Cut		$a_p=1"$ $a_e=.3937"$	
Coolant		Dry	

Comparison of surface finish and cutting force

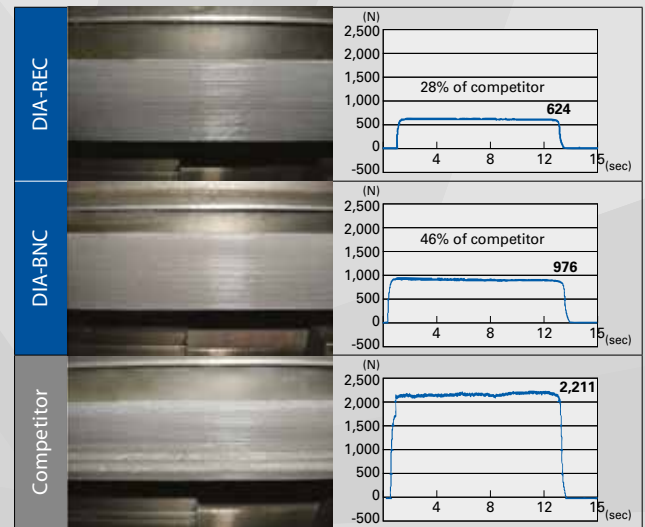

Long tool life in CFRP panel milling

DIA-REC can complete 6 parts per cutter and shows 3 times longer tool life than competitor.

Tool	DIA-REC	Competitor
Size		3/8"
Work Material		CFRP (Panel)
Milling Speed		6,500 RPM
Feed		60 IPM
Depth of Cut		$a_a=.375"$ $a_r=.250"$
Coolant		Dry
Machine		5-axis Machine

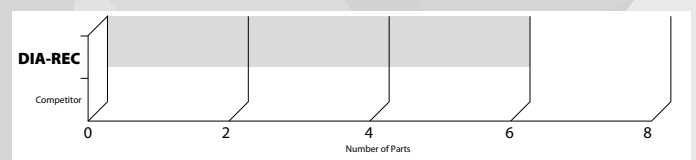
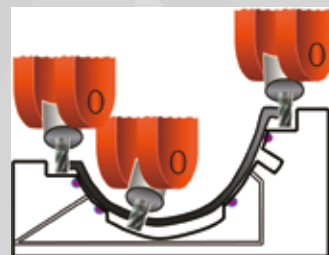

KEY FEATURES DIA-MFC

Diamond Coated Finishing Router

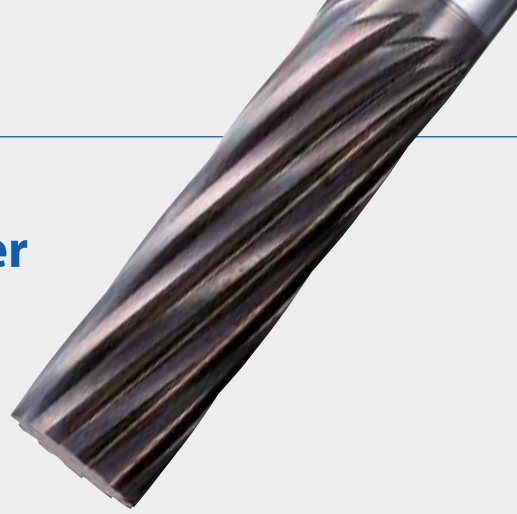

Low Helix

Provides higher rake angles than straight flutes to minimize vibration.

Multiple Flutes

For excellent surface finish and high efficiency.



Large Core

Enables greater rigidity.

OSG Diamond Coating (PAT.)

Provides superior wear resistance and anti-welding properties.

Excellent for tight tolerance

The DIA-MFC showed the best accuracy versus a competitor diamond coated finishing router as well as other electroplated products.

Tool	DIA-MFC (Special)	Competitor	Electroplated
Work Material	Carbon / Carbon Composite		
Size	5/16"		
Milling Method	Slotting		
Milling Speed	2,700 RPM		9,795 RPM
Feed	50 IPM		
Depth of Cut	$a_p = .400"$		
Coolant	Dry		

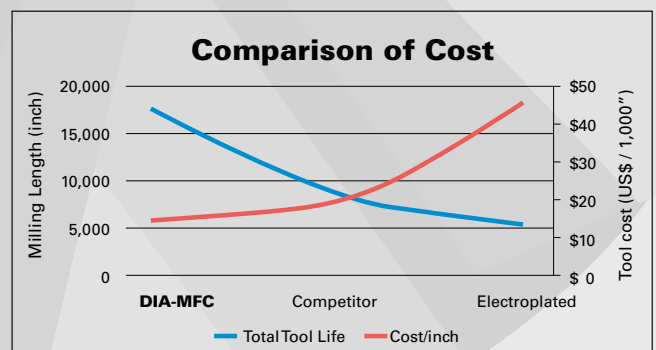
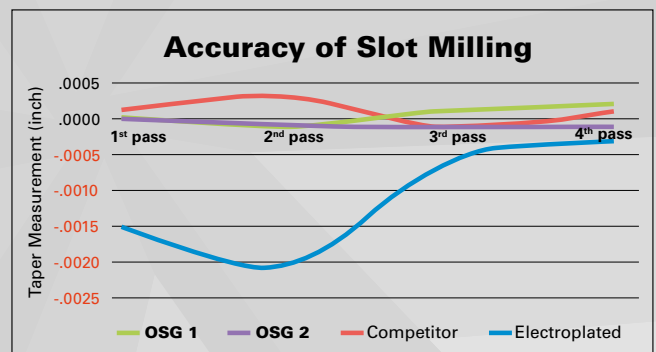

DIA-MFC showed 3.2 times longer tool life and 66% lower tool cost than a diamond electroplated router.

KEY FEATURES: PFB

Finishing ball end mill



Feature of insert

- High Radius precision
- Spiral cutting edge with excellent sharpness

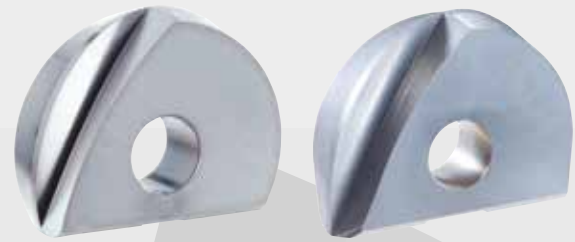
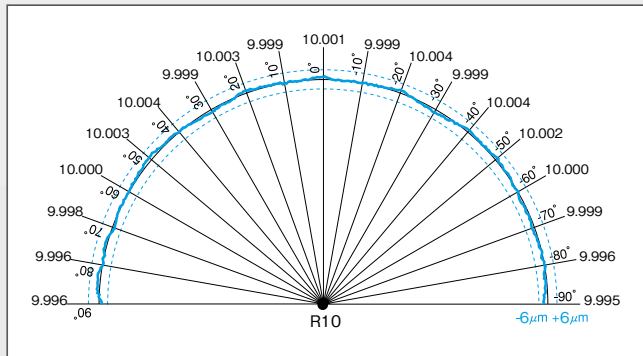

PFB-D

- Sharp cutting edge specialized for milling graphite
- Highly adhesive carbide material for diamond coating

XC4505 Grade

- For milling nonferrous material
- Optimal diamond coating for milling graphite

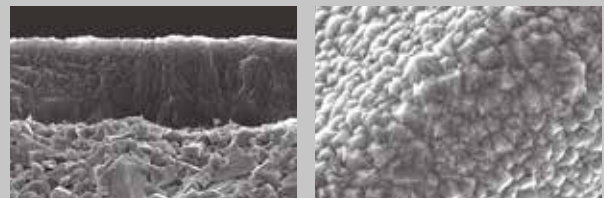

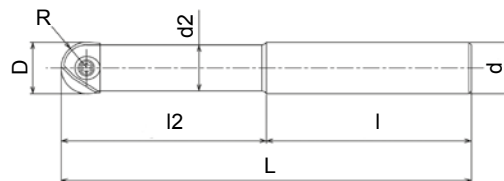

- Finishing ball nose cutter
- Excellent sharpness
- Cylindrical type
- 6 - 32 mm

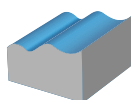

EDP	Body size	Designation	Z	D	R	l2	l2/D	l	L	d2	d	Specification	Price
7801429	①	PFB-R060SS06-S80CS	2	6	3	15	2,5	65	80	5,4	6	Carbide	
7801439	①	PFB-R060SS06-L100CS	2	6	3	30	5	70	100	5,4	6	Carbide	
7801419	①	PFB-R060SS06-LL120CS	2	6	3	42	7	78	120	5,4	6	Carbide	
7801430	②	PFB-R080SS08-S100CS	2	8	4	20	2,5	80	100	7	8	Carbide	
7801440	②	PFB-R080SS08-L120CS	2	8	4	40	5	80	120	7	8	Carbide	
7801420	②	PFB-R080SS08-LL140CS	2	8	4	56	7	84	140	7	8	Carbide	
7801431	③	PFB-R100SS10-S100CS	2	10	5	25	2,5	75	100	9	10	Carbide	
7801441	③	PFB-R100SS10-L130CS	2	10	5	50	5	80	130	9	10	Carbide	
7801421	③	PFB-R100SS10-LL150CS	2	10	5	70	7	80	150	9	10	Carbide	
7801432	④	PFB-R120SS12-S110CS	2	12	6	30	2,5	80	110	11	12	Carbide	
7801442	④	PFB-R120SS12-L140CS	2	12	6	60	5	80	140	11	12	Carbide	
7801422	④	PFB-R120SS12-LL160CS	2	12	6	84	7	76	160	11	12	Carbide	
7801433	⑤	PFB-R160SS16-S140CS	2	16	8	40	2,5	100	140	14	16	Carbide	
7801443	⑤	PFB-R160SS16-L160CS	2	16	8	72	4,5	88	160	14	16	Carbide	
7801423	⑤	PFB-R160SS16-LL200CS	2	16	8	96	6	104	200	14	16	Carbide	
7801434	⑥	PFB-R200SS20-S160CS	2	20	10	50	2,5	110	160	18	20	Carbide	
7801444	⑥	PFB-R200SS20-L180CS	2	20	10	90	4,5	90	180	18	20	Carbide	
7801424	⑥	PFB-R200SS20-LL240CS	2	20	10	120	6	120	240	18	20	Carbide	
7801435	⑦	PFB-R250SS25-S160CS	2	25	12,5	62,5	2,5	97,5	160	22	25	Carbide	
7801445	⑦	PFB-R250SS25-L200CS	2	25	12,5	100	4	100	200	22	25	Carbide	
7801425	⑦	PFB-R250SS25-LL260CS	2	25	12,5	137,5	5,5	122,5	260	22	25	Carbide	
7801436	⑧	PFB-R300SS32-S170CS	2	30	15	75	2,5	95	170	27	32	Carbide	
7801446	⑧	PFB-R300SS32-L220CS	2	30	15	120	4	100	220	27	32	Carbide	
7801426	⑧	PFB-R300SS32-LL290CS	2	30	15	165	5,5	125	290	27	32	Carbide	
7801437	⑨	PFB-R320SS32-S180CS	2	32	16	80	2,5	100	180	29	32	Carbide	
7801447	⑨	PFB-R320SS32-L230CS	2	32	16	128	4	102	230	29	32	Carbide	
7801427	⑨	PFB-R320SS32-LL300CS	2	32	16	176	5,5	124	300	29	32	Carbide	
7801400	②	PFB-R080SS08-S120	2	8	4	36	4,5	84	120	7	8	Steel	
7801401	③	PFB-R100SS10-S130	2	10	5	45	4,5	85	130	9	10	Steel	
7801402	④	PFB-R120SS12-S130	2	12	6	54	4,5	76	130	11	12	Steel	
7801403	⑤	PFB-R160SS16-S140	2	16	8	64	4	76	140	14	16	Steel	
7801404	⑥	PFB-R200SS20-S160	2	20	10	80	4	80	160	18	20	Steel	
7801405	⑦	PFB-R250SS25-S160	2	25	12,5	75	3	85	160	22	25	Steel	
7801406	⑧	PFB-R300SS32-S170	2	30	15	90	3	80	170	27	32	Steel	
7801407	⑨	PFB-R320SS32-S180	2	32	16	96	3	84	180	29	32	Steel	

Accessories & spare parts

Applicable cutter Ø	Tightening torque (recommended)		Clamping screw		Wrench	
Ø 6	0,8Nm		7808124	FS20652RB	7808203	T6-D
Ø 8	1Nm		7808123	FS25669RB	7808204	T7-D
Ø 10	1,2Nm		7808117	FS30686RB	7808205	T8-D
Ø 12	2Nm		7808118	FS35610RB	7808207	T10-D
Ø 16	3Nm		7808119	FS40613RB	7808208	T15-D
Ø 20	5Nm		7808120	FS50615RB	7808209	T20-D
Ø 25	5Nm		7808121	FS60620RB	7808209	T20-D
Ø 30,32	6Nm		7808122	FS80624RB	7808212	T30-T



PFB INSERTS

Milling | Indexables

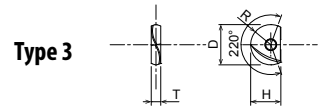
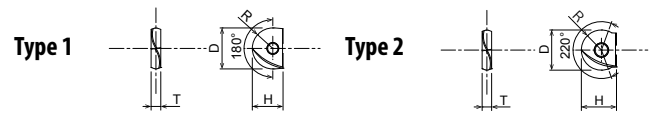

- Finishing ball nose cutter
- Excellent sharpness
- 6 - 32 mm

page 29

Type	EDP	Designation	Z	Range degree	Dc	R	T	H	Grade	P		M		K		N		S		H		Body size
										dry	water	dry	water	GG	GGG	dry	water	dry	water	dry	water	
1	7820030	PFB080-SP	2	180°	8	4	2,4	7	XP3225	●		●										②
1	7820031	PFB100-SP	2	180°	10	5	2,6	8,5	XP3225	●		●										③
1	7820032	PFB120-SP	2	180°	12	6	3	10	XP3225	●		●										④
1	7820033	PFB160-SP	2	180°	16	8	4	12	XP3225	●		●										⑤
1	7820034	PFB200-SP	2	180°	20	10	5	15	XP3225	●		●										⑥
1	7820035	PFB250-SP	2	180°	25	12,5	6	18,5	XP3225	●		●										⑦
1	7820036	PFB300-SP	2	180°	30	15	7	22,5	XP3225	●		●										⑧
1	7820010	PFB080-SP	2	180°	8	4	2,4	7	XP3320	○		○							●	○		②
1	7820011	PFB100-SP	2	180°	10	5	2,6	8,5	XP3320	○		○							●	○		③
1	7820012	PFB120-SP	2	180°	12	6	3	10	XP3320	○		○							●	○		④
1	7820013	PFB160-SP	2	180°	16	8	4	12	XP3320	○		○							●	○		⑤
1	7820014	PFB200-SP	2	180°	20	10	5	15	XP3320	○		○							●	○		⑥
1	7820015	PFB250-SP	2	180°	25	12,5	6	18,5	XP3320	○		○							●	○		⑦
1	7820016	PFB300-SP	2	180°	30	15	7	22,5	XP3320	○		○							●	○		⑧
2	7820039	PFB060-SH	2	220°	6	3	2	5	XP3310					●	●						●	①
1	7820040	PFB080-SH	2	180°	8	4	2,4	7	XP3310					●	●						●	②
1	7820041	PFB100-SH	2	180°	10	5	2,6	8,5	XP3310					●	●						●	③
1	7820042	PFB120-SH	2	180°	12	6	3	10	XP3310					●	●						●	④
1	7820043	PFB160-SH	2	180°	16	8	4	12	XP3310					●	●						●	⑤
1	7820044	PFB200-SH	2	180°	20	10	5	15	XP3310					●	●						●	⑥
1	7820045	PFB250-SH	2	180°	25	12,5	6	18,5	XP3310					●	●						●	⑦
1	7820046	PFB300-SH	2	180°	30	15	7	22,5	XP3310					●	●						●	⑧
1	7820047	PFB320-SH	2	180°	32	16	7	23,5	XP3310					●	●						●	⑨
2	7820018	PFB060-D	2	220°	6	3	2	5	XC4505					●								①
2	7820019	PFB070-D	2	220°	7	3,5	2	5,5	XC4505					●								①
1	7820020	PFB080-D	2	180°	8	4	2,4	7	XC4505					●	●							②
1	7820021	PFB100-D	2	180°	10	5	2,6	8,5	XC4505					●	●							③
1	7820022	PFB120-D	2	180°	12	6	3	10	XC4505					●	●							④
1	7820023	PFB160-D	2	180°	16	8	4	12	XC4505					●	●							⑤
1	7820024	PFB200-D	2	180°	20	10	5	15	XC4505					●	●							⑥
1	7820025	PFB250-D	2	180°	25	12,5	6	18,5	XC4505					●	●							⑦
1	7820026	PFB300-D	2	180°	30	15	7	22,5	XC4505					●	●							⑧
2	7820048	PFB060-Q	2	220°	6	3	2	5	XP3225	●		●								○		①
2	7820049	PFB070-Q	2	220°	7	3,5	2	5,5	XP3225	●		●								○		①
2	7820050	PFB080-Q	2	220°	8	4	2,4	7	XP3225	●		●								○		②
2	7820051	PFB100-Q	2	220°	10	5	2,6	8,5	XP3225	●		●								○		③
2	7820052	PFB120-Q	2	220°	12	6	3	10	XP3225	●		●								○		④
3	7820053	PFB160-Q	2	220°	16	8	4	12	XP3225	●		●								○		⑤
3	7820054	PFB200-Q	2	220°	20	10	5	15	XP3225	●		●								○		⑥
3	7820055	PFB250-Q	2	220°	25	12,5	6	18,5	XP3225	●		●								○		⑦
3	7820056	PFB300-Q	2	220°	30	15	7	22,5	XP3225	●		●								○		⑧

Milling | Indexables

Inserts

CUTTING CONDITIONS

Milling | Indexables | Cutting conditions

PFB-SP, PFB-SH, PFB-Q

Finishing ball nose cutter

	Work Material	Tensile Strength / Hardness	Milling Speed Vc (m/min)	Depth of Cut ap (mm)	Feed per Tooth fz (mm/t)			
					D			
					Ø 6,8	Ø 10,12	Ø 16,20	Ø 25-30-32
P	Mild Steel-Carbon Steel (SS400-S10C)	~180HB	300 (200~ 400)	0,02 D	0,1	0,12	0,14	0,18
	Carbon Steel-Alloy Steel (S50C-SCM440)	~280HB	300 (200~ 400)	0,02 D	0,07	0,1	0,12	0,14
	Die Steel (SKD11-SKD61)	~280HB	250 (150 ~ 350)	0,02 D	0,07	0,1	0,12	0,14
M	Stainless Steel (Dry) (SUS304-SUS420)	~250HB	250 (150 ~ 350)	0,02 D	0,07	0,12	0,14	0,17
K	Cast Iron (FC250)	~300N/mm ²	400 (300~ 500)	0,02 D	0,12	0,14	0,18	0,22
	Ductile Cast Iron (FCD400)	~600N/mm ²	300 (200~ 400)	0,02 D	0,1	0,12	0,14	0,18
N	Aluminium Alloy	~13% Si	500 (400~ 600)	0,03 D	0,12	0,14	0,18	0,22
	Copper Alloy (C1100)	-	300 (200 ~ 400)	0,03 D	0,11	0,13	0,17	0,22
S	Heat Resistant Alloys (Wet) (Inconel 718)	-	50 (25~ 80)	0,015 D	0,04	0,05	0,06	0,06
	Titanium Alloy (Wet) (Ti-Al-4V)	-	90 (40~120)	0,02 D	0,06	0,08	0,11	0,13
H	Pre-hardened Steel (NAK80, STAVAX)	40~43HRC	200 (100~ 300)	0,015 D	0,06	0,07	0,08	0,1
	Steel for Die Casting (DAC55-DH31)	43~48HRC	180 (90 ~ 200)	0,015 D	0,05	0,06	0,07	0,07
	Hardened Steel (SKD11)	50~60HRC	150 (100 ~ 250)	0,01 D	0,05	0,06	0,07	0,07

PFB-D

Finishing ball nose cutter

	Work Material	Tensile Strength / Hardness	Milling Speed Vc (m/min)	Depth of Cut ap (mm)	Feed per Tooth fz (mm/t)			
					D			
					Ø 6,8	Ø 10,12	Ø 16,20	Ø 25-30-32
N	Graphite	-	500 (400~ 600)	0,03 D	0,14	0,17	0,21	0,25
	CFRP Carbon Fiber Reinforced Plastic	-	300 (300 ~ 500)	0,03 D	0,11	0,13	0,17	0,20



CUTTING CONDITIONS

Milling | Indexables | Cutting conditions

PFB

Chart of cutting depth and actual cutting diameter

Depth of cut		Actual cutting diameter															
D	R	0,1	0,2	0,3	0,4	0,5	0,8	1	1,5	2	2,5	3	3,5	4	4,5	5	
6	3	1,5	2,2	2,6	3	3,3	4,1	-	-	-	-	-	-	-	-	-	
7	3,5	1,6	2,3	2,8	3,3	3,6	4,5	-	-	-	-	-	-	-	-	-	
8	4	1,8	2,5	3	3,5	3,9	4,8	-	-	-	-	-	-	-	-	-	
10	5	2	2,8	3,4	3,9	4,4	5,4	6	7,1	-	-	-	-	-	-	-	
12	6	2,2	3,1	3,7	4,3	4,8	6	6,6	7,9	8,9	-	-	-	-	-	-	
16	8	2,5	3,6	4,3	5	5,6	7	7,7	9,3	10,6	11,6	-	-	-	-	-	
20	10	2,8	4	4,9	5,6	6,2	7,8	8,7	10,5	12	13,2	14,3	15,2	-	-	-	
25	12,5	3,2	4,5	5,4	6,3	7	8,8	9,8	11,9	13,6	15	16,2	17,3	18,3	-	-	
30	15	3,5	4,9	6	6,9	7,7	9,7	10,8	13,1	15	16,6	18	19,3	20,4	21,4	22,4	
32	16	3,6	5	6,2	7,1	7,9	10	11,1	13,5	15,5	17,2	18,7	20	21,2	22,2	23,2	

How to determine actual cutting diameter D

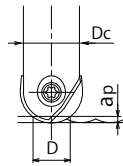

$$D = 2 \sqrt{ap(Dc - ap)}$$

Recommended pick feed and milling surface roughness

Unit: mm

D	6	7	8	10	12	16	20	25	30	32
Pf	0,4	0,45	0,5	0,6	0,7	0,8	1	1,2	1,3	1,4
h	0,007	0,007	0,008	0,009	0,01	0,01	0,012	0,014	0,014	0,015

Theoretical milling surface roughness

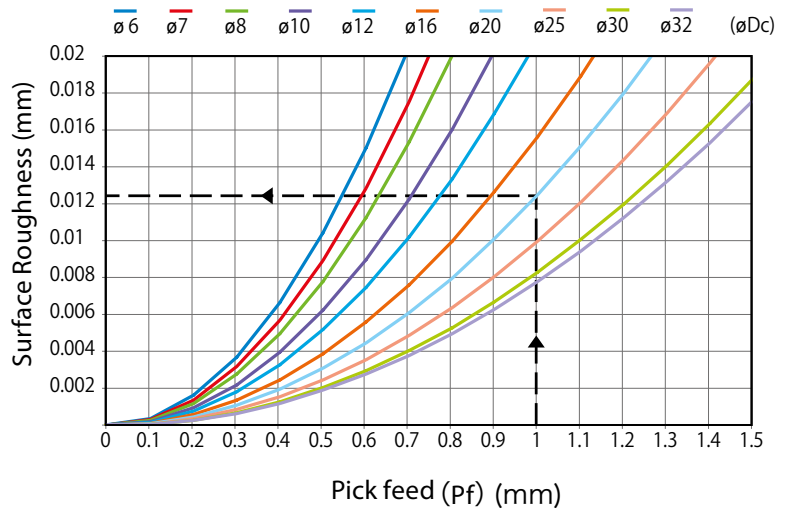
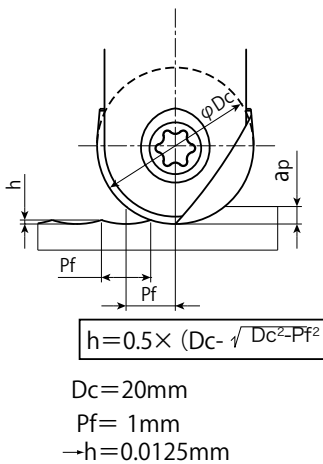

CUTTING CONDITIONS

Milling | Cutting conditions

D-STAD

CFRP		
Vc	50 ~ 100 m/min	
Ø	RPM	F (mm/rev.)
4	4.000 ~ 8.000	0,03 ~ 0,05
6	2.600 ~ 5.300	0,04 ~ 0,075
6,35	2.500 ~ 5.000	0,04 ~ 0,075
8	2.000 ~ 4.000	0,05 ~ 0,08

D-DAD

CFRP		
Vc	60 ~ 120 m/min	
Ø	Speed (min ⁻¹)	F (mm/rev.)
2,5	11.000	0,03 ~ 0,05
3,27	8.700	0,03 ~ 0,05
4,10	7.000	0,03 ~ 0,05
4,86	6.000	0,03 ~ 0,05
6,37	4.500	0,05 ~ 0,10
9,55	3.000	0,05 ~ 0,10

1. Although coolant is not required, please take adequate measurement against dust (use a vacuum system).
2. The machinability of CFRP varies based on resin type, resin content and clamping method. For thin laminates, reduce feed rate near hole penetration according to the above recommended cutting conditions.
3. Reduce cutting speed accordingly when machining thick laminates.
4. Cutting speed up to 200m/min is possible when drilling with approved coolant fluid.

D-GDN90

CFRP		
Vc	60 ~ 120 m/min	
Ø	Speed (min ⁻¹)	F (mm/rev.)
2,5	11.000	0,03 ~ 0,05
3,27	8.700	0,03 ~ 0,05
4,10	7.000	0,03 ~ 0,05
4,86	6.000	0,03 ~ 0,05
6,37	4.500	0,05 ~ 0,10
9,55	3.000	0,05 ~ 0,10

1. Although coolant is not required, please take adequate measurement against dust (use a vacuum system).
2. The machinability of CFRP varies based on resin type, resin content and clamping method. For thin laminates, reduce feed rate near hole penetration according to the above recommended cutting conditions.
3. Reduce cutting speed accordingly when machining thick laminates.
4. Cutting speed up to 200m/min is possible when drilling with approved coolant fluid.

CUTTING CONDITIONS

Milling | Cutting conditions

DIA-BNC

Trimming & plunging operation

Vc	Side Milling ap: <1,5D / ae: <1D		Slotting ap: 1D	
	120 (m/min)	240 (m/min)	90 (m/min)	180 (m/min)
Ø	F (mm/min)	F (mm/min)	F (mm/min)	F (mm/min)
6	770	1.600	380	750
8	900	1.800	450	900
10	1.000	2.000	510	1.000
12	1.300	2.600	630	1.300

DIA-HBC

Vc	Side Milling ap: <1,5D / ae: <1D		Slotting ap: 1D	
	120 (m/min)	240 (m/min)	90 (m/min)	180 (m/min)
Ø	F (mm/min)	F (mm/min)	F (mm/min)	F (mm/min)
6	770	1.600	380	750
8	900	1.800	450	900
10	1.000	2.000	510	1.000
12	1.300	2.600	630	1.300

Note: This table's parameters are based on common material thickness of approximately 0,250" under excellent workholding conditions and less than 20% x D depth of cut (side milling). Please adjust your parameters properly for your application or call OSG for assistance.
Conventional milling is recommended for better surface finishes. Higher feed rates are possible but quality of part and surface should be considered.

Feed reduction by thickness of part: Recommended feed adjustments based on thickness of part. (Above table is based on approximately 1xD thickness.)

≤0,5D	x 150%
0,5D-1D	x 120%
1D-2D	x 80%
3D-4D	x 50%

HBC60

S (min ⁻¹)	Feed rate		
	(mm/rev)	IPR	
Vc	300~600 (m/min)		
6	20.000 ~ 30.000	0,02 ~ 0,06	0,001 ~ 0,002
8	15.000 ~ 24.000	0,02 ~ 0,06	0,001 ~ 0,002
10	12.000 ~ 19.000	0,02 ~ 0,07	0,001 ~ 0,003
12	10.000 ~ 16.000	0,02 ~ 0,1	0,001 ~ 0,004

≤0,25D	x 80%
0,25D-0,5D	x 150%
0,5D-1D	x 120%
1D-2D	x 80%
2D-3D	x 50%

DIA-REC

S (min ⁻¹)	Feed rate		
	(mm/rev)	IPR	
Vc	100~180 (m/min)		
6	5.300 ~ 9.500	0,1 ~ 0,12	0,004 ~ 0,005
8	4.000 ~ 7.200	0,16 ~ 0,25	0,006 ~ 0,01
10	3.200 ~ 5.700	0,24 ~ 0,3	0,009 ~ 0,012

≤0,25D	x 80%
0,25D-0,5D	x 150%
0,5D-1D	x 120%
1D-2D	x 80%
2D-3D	x 50%

DIA-MFC

S (min ⁻¹)	Feed rate		
	(mm/rev)	IPR	
Vc	100~180 (m/min)		
6	5.300 ~ 9.500	0,16 ~ 0,24	0,006 ~ 0,009
8	4.000 ~ 7.000	0,3 ~ 1	0,012 ~ 0,039
10	3.200 ~ 5.700	0,48 ~ 1,2	0,019 ~ 0,047

≤0,25D	x 80%
0,25D-0,5D	x 150%
0,5D-1D	x 120%
1D-2D	x 80%
2D-3D	x 50%

www.osgeurope.com

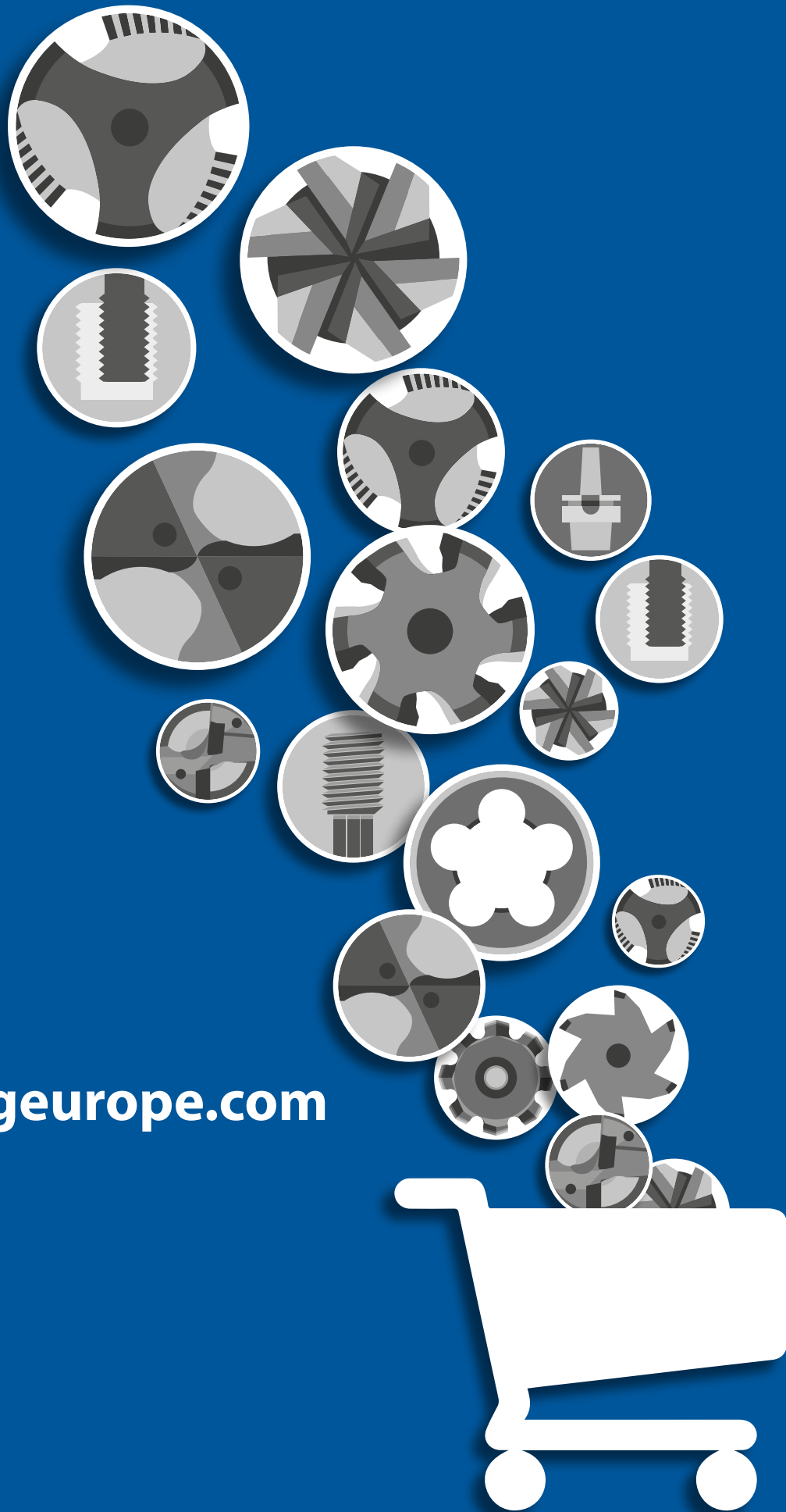



shaping your dreams

OSG EUROPE LOGISTICS

Avenue Lavoisier 1
B-1300 Z.I. Wavre - Nord - Belgium
Tel: +32 10 23 05 07
Fax: +32 10 23 05 51
info@osgeurope.com

OSG BELUX

Avenue Lavoisier 1
B-1300 Z.I. Wavre - Nord - Belgium
Tel: +32 10 23 05 11
Fax: +32 10 23 05 31
info@osg-belgium.com

OSG FRANCE

Parc Icade, Paris Nord 2
Immeuble "Le Rimbaud"
22 Avenue des Nations
CS66191 - 93420 Villepinte - France
Tel: +33 1 49 90 10 10
Fax: +33 1 49 90 10 15
sales@osg-france.com

OSG NETHERLANDS

Bedrijfsweg 5 - 3481 MG Harmelen
Tel: +31 348 44 2764
Fax: +31 348 44 2144
info@osg-nl.com

OSG UK

Shelton house, 5 Bentalls
Pipps Hill Ind Est, Basildon Essex SS14 3BY
Tel: +44 845 305 1066
Fax: +44 845 305 1067
sales@osg-uk.com

SLOVAKIA

Branch office of OSG Europe Logistics s.a.
Tel (SK) +421 2 4329 1295
Tel (BE) +32 10 23 05 07
Fax (BE) +32 10 23 05 51
sales-osgsvk@osgeurope.com

OSG POLAND Sp. z.o.o.

Spółdzielcza 57
05-074 Halinów - Poland
Tel: +22 760 82 71
Fax: +22 760 82 71
osg@osg-poland.com

OSG GERMANY

Karl-Ehmann-Str. 25
D - 73037 Göppingen - Germany
Tel: +49 7161 6064 - 0
Fax: +49 7161 6064 - 444
info@osg-germany.de

OSG SCANDINAVIA

(For Scandinavian countries)
Langebjergvaenget 16
4000 Roskilde - Denmark
Tel: +45 46 75 65 55
Fax: +45 46 75 67 00
osg@osg-scandinavia.com

SWEDEN

Branch office of OSG SCANDINAVIA
Abrahams Gränd 8
295 35 Bromölla - Sweden
Tel: +46 40 41 22 55
Fax: +46 40 41 32 55
osg@osg-scandinavia.com

OSG IBERICA

Bekolarra 4
E - 01010 Vitoria-Gasteiz - Spain
Tel: +34 945 242 400
Fax: +34 945 228 883
osg.iberica@osg-ib.com

RUSSIA

Butlerova street, 17B, office 5069
117342 Moscow - Russia
Tel: +7 (495) 150 41 54
info@osg-russia.com

OSG TURKEY

Rami Kışla Cad.No:56 Eyüp
Istanbul 34056 - Turkey
Tel:+90 212 565 24 00
Fax: +90 212 565 44 00
info@osg-turkey.com

ROMSAN INTERNATIONAL CO. SRL

Reprezentant Exclusiv OSG
23-25, Nerva Traian Street
031044 Bucuresti - România
Tel: +40 021 322 07 47
Fax: +40 021 321 56 00
romsan.int@romsan.ro

AUSTRIA

Branch office of OSG GERMANY
Messestraße 11
A-6850 Dornbirn
Tel: +49 7161 6064-0
Fax: +49 7161 6064-444
info@osg-germany.de

OSG ITALIA

Via Cirenaiica n. 52 int. 61/63
I - 10142 Torino - Italy
Tel: +39 0117705211
Fax: +39 0117071402
info@osg-italia.it

Vischer & Bolli AG

Im Schossacher 17
CH-8600 Dübendorf
Schweiz
Tel.: +41 44 802 15 15
Fax: +41 44 802 15 95
info@vb-tools.com

OSG EUROPE LOGISTICS S.A.

12/2018 - All rights reserved. © OSG Europe 2018

The contents of this catalogue are provided to you for viewing only. They are not intended for reproduction either in part or in whole in this or other medium. They cannot be copied, used to create derivation work or used for any reason, by means without the express, written permission of the copyright owner. If prices are stated, they are netto unit-prices and any eventual tax(es) have to be added. The company is not responsible for any printing error in technical, price and/or any other data.

Tool specifications subject to change without notice.

www.osgeurope.com

